



TEST REPORT
FCC ID: SY4-A01010
For
Shanghai Huace Navigation Technology LTD.
GNSS Receiver

Model No. : i70, iG8

Trade name : 

Prepared for : Shanghai Huace Navigation Technology LTD.
Address : Building C,599 Gaojing Road,Qingpu District,Shanghai,China

Prepared by : Shenzhen Alpha Product Testing Co., Ltd.
Address : Building B, East Area of Nanchang Second, Industrial Zone,
Gushu 2nd Road, Bao'an, Shenzhen, China

Report No. : T1871060 02

Date of Receipt : June 22, 2017

Date of Test : June 22, 2017- July 11, 2017

Date of Report : July 11, 2017

TABLE OF CONTENT

Description	Page
1. Summary of Standards and Results -----	5
1.1. Description of Standards and Results -----	5
2. General Information -----	6
2.1. Description of Device (EUT)-----	6
2.2. Accessories of Device (EUT) -----	7
2.3. Tested Supporting System Details -----	7
2.4. Test Mode Description -----	7
2.5. Test Conditions-----	7
2.6. Block Diagram of connection between EUT and simulators-----	7
2.7. Test Facility-----	8
2.8. Measurement Uncertainty -----	8
2.9. Test Equipment List -----	9
3. Spurious Emission -----	10
3.1. Test Limits -----	10
3.2. Test Procedure-----	10
3.3. Test Setup -----	11
3.4. Test Results -----	12
4. Power Line Conducted Emission -----	16
4.1. Test Limits -----	16
4.2. Test Procedure-----	16
4.3. Test Setup -----	16
4.4. Test Results -----	17
5 Conducted Maximum Output Power-----	19
5.1 Test limits-----	19
5.2 Test Procedure-----	19
5.3 Test Setup-----	19
5.4 Test Results-----	19
6 Peak Power Spectral Density -----	20
6.1 Test limits-----	20
6.2 Test Procedure-----	20
6.3 Test Setup-----	20
6.4 Test Results-----	21
7 Bandwidth -----	23
7.1 Test limits-----	23
7.2 Test Procedure-----	23
7.3 Test Setup-----	23
7.4 Test Results-----	23
8 Band Edge Check -----	26
8.1 Test limits-----	26
8.2 Test Procedure-----	26
8.3 Test Setup-----	26
8.4 Test Results-----	26

9	Antenna Requirement	28
9.1	Standard Requirement	28
9.2	Antenna Connected Construction	28
9.3	Results	28

DECLARATION

Applicant : Shanghai Huace Navigation Technology LTD.
 Manufacturer : Shanghai Huace Navigation Technology LTD.
 Product : GNSS Receiver
 (A) Model No. : i70, iG8
 (B) Trade Name : 
 (C) Power supply : DC 15V from adapter input 120V/60Hz

Measurement Standard Used:

FCC Rules and Regulations Part 15 Subpart C Section 15.247: 2016,
ANSI C 63.4-2014, ANSI C63.10-2013

The device described above is tested by Shenzhen Alpha Product Testing Co., Ltd. to determine the maximum emission levels emanating from the device. The maximum emission levels are compared to the FCC Part 15 Subpart B Class B limits both conducted and radiated emissions. The test results are contained in this test report and Shenzhen Alpha Product Testing Co., Ltd. is assumed of full responsibility for the accuracy and completeness of these tests.

After the test, our opinion is that EUT compliance with the requirement of the above standards.

This report applies to above tested sample only. This report shall not be reproduced in parts without written approval of Shenzhen Alpha Product Testing Co., Ltd.

Tested by (name + signature).....: Reak Yang
 Project Engineer

Approved by (name + signature).....: Simple Guan
 Project Manager

Date of issue.....: July 11, 2017



1. Summary of Standards and Results

1.1. Description of Standards and Results

Note: The EUT has been tested as an independent unit. And Continual Transmitting in maximum power (The adapter be used during Test)

Test Item	Test Requirement	Standards Paragraph	Result
Spurious Emission	FCC PART 15:2016	Section 15.247&15.209	P
Conduction Emission	FCC PART 15:2016	Section 15.207	P
Bandwidth Test	FCC PART 15:2016	Section 15.247	P
Peak Power	FCC PART 15:2016	Section 15.247	P
Power Density	FCC PART 15:2016	Section 15.247	P
Band Edge	FCC PART 15:2016	Section 15.247	P
Antenna Requirement	FCC PART 15:2016	Section 15.203	P
Note:	1. P is an abbreviation for Pass. 2. F is an abbreviation for Fail. 3. N/A is an abbreviation for Not Applicable.		

2. General Information

2.1. Description of Device (EUT)

Trade Name :  CHC

EUT : GNSS Receiver

Model No. : i70, iG8

DIFF : All the models are the same, except the model name, this report performs the model i70.

Antenna Type : PCB Antenna, Maximum Gain is 1.0dBi

Operation Frequency : 2402-2480MHz

Channel number : 40 Channels

Modulation type : GFSK

Power Supply : DC 15V from adapter input 120V/60Hz

Applicant : Shanghai Huace Navigation Technology LTD.

Address : Building C,599 Gaojing Road,Qingpu District,Shanghai,China

Manufacturer : Shanghai Huace Navigation Technology LTD.

Address : Building C,599 Gaojing Road,Qingpu District,Shanghai,China

2.2. Accessories of Device (EUT)

Power Source	:	Input: AC 100-240V Output: DC 12-36V/2A LI-ION battery: 3400mAh/7.4V*2
USB Cable	:	USB port to PC 1.5m
Data Cable	:	IO port to PC with RS-232/external power 1.8m

2.3. Tested Supporting System Details

No.	Description	Manufacturer	Model	Serial Number	Certification or DOC
1	Notebook	ACER	ZQT	N/A	DOC

2.4. Test Mode Description

Tested mode, channel, and data rate information		
Mode	Channel	Frequency (MHz)
GFSK	Low :CH1	2402
	Middle: CH20	2440
	High: CH40	2480

2.5. Test Conditions

Items	Required	Actual
Temperature range:	15-35°C	27°C
Humidity range:	25-75%	56%
Pressure range:	86-106kPa	980kPa

2.6. Block Diagram of connection between EUT and simulators



2.7. Test Facility

Shenzhen Alpha Product Testing Co., Ltd
 Building B, East Area of Nanchang Second, Industrial Zone, Gushu 2nd Road,
 Bao'an, Shenzhen, China

August 11, 2014 File on Federal Communication Commission
 Registration Number: 203110

July 18, 2014 Certificated by IC
 Registration Number: 12135A

2.8. Measurement Uncertainty

(95% confidence levels, k=2)

Item	Uncertainty
Uncertainty for Power point Conducted Emissions Test	2.71dB
Uncertainty for Radiation Emission test in 3m chamber (below 30MHz)	2.13 dB(Polarize: V)
	2.57dB(Polarize: H)
Uncertainty for Radiation Emission test in 3m chamber (30MHz to 1GHz)	3.90 dB(Polarize: V)
	3.92dB(Polarize: H)
Uncertainty for Radiation Emission test in 3m chamber (1GHz to 25GHz)	4.26 dB(Polarize: H)
	4.28 dB(Polarize: V)
Uncertainty for radio frequency	1×10^{-9}
Uncertainty for DC and low frequency voltages	0.06%

2.9. Test Equipment List

Equipment	Manufacture	Model No.	Serial No.	Cal. Date	Cal Interval
3m Semi-Anechoic	ETS-LINDGREN	N/A	SEL0017	2017.01.16	1Year
Spectrum analyzer	Agilent	E4407B	MY46185649	2017.01.16	1Year
Receiver	R&S	ESCI	1166.5950K03-1011	2017.01.16	1Year
Receiver	R&S	ESCI	101202	2017.01.16	1Year
Bilog Antenna	Schwarzbeck	VULB 9168	VULB9168-438	2018.01.18	2Year
Horn Antenna	EMCO	3115	640201028-06	2018.01.18	2Year
Active Loop Antenna	Beijing Daze	ZN30900A	SEL0097	2018.01.18	2Year
Cable	Resenberger	N/A	No.1	2017.01.16	1Year
Cable	SCHWARZBECK	N/A	No.2	2017.01.16	1Year
Cable	SCHWARZBECK	N/A	No.3	2017.01.16	1Year
Pre-amplifier	Schwarzbeck	BBV9743	9743-019	2017.01.16	1Year
Pre-amplifier	R&S	AFS33-18002650-30-8P-44	SEL0080	2017.01.16	1Year
Base station	Agilent	E5515C	GB44300243	2017.01.16	1 Year
Temperature controller	Terchy	MHQ	120	2017.01.16	1Year
Power divider	Anritsu	K240C	020346	2017.01.16	1 Year
Signal Generator	HP	83732B	VS3449051	2017.01.16	1 Year
Power Meter	Anritsu	ML2487A	6K00001491	2017.01.16	1Year
Power sensor	Anritsu	ML2491A	32516	2017.01.16	1Year
L.I.S.N.#1	Schwarzbeck	NSLK8126	8126466	2017.01.16	1Year
L.I.S.N.#2	ROHDE&SCHWARZ	ENV216	101043	2017.01.16	1 Year

3. Spurious Emission

3.1. Test Limits

Frequencies (MHz)	Field Strength (micorvolts/meter)	Measurement Distance (meters)
0.009~0.490	2400/F(KHz)	300
0.490~1.705	24000/F(KHz)	30
1.705~30.0	30	30
30~88	100	3
88~216	150	3
216~960	200	3
Above 960	500	3

Harmonic emissions limits comply with below 54 dBuV/m at 3m. Other emissions radiated outside of the specified frequency bands, except for harmonics, shall be attenuated by at least 50 dB below the level of the fundamental or comply with the radiated emissions limits specified in section 15.209(a) limit in the table below has to be followed.

NOTE:

- a) The tighter limit applies at the band edges.
- b) Emission Level(dB uV/m)=20log Emission Level(uv/m)

3.2. Test Procedure

The measuring distance of 3m shall be used for measurements at frequency up to 1GH and above 1GHz, The EUT was placed on a rotating 0.8 m high above ground for below 1GHz and 1.5m high for above1GHz testing, The table was rotated 360 degrees to determine the position of the highest radiation

The Test antenna shall vary between 1m and 4m, Both Horizontal and Vertical antenna are set of make measurement.

The initial step in collecting conducted emission data is a spectrum analyzer Peak detector mode pre-scanning the measurement frequency range. Significant Peaks are then marked. and then Qusia Peak Detector mode premeasured

If Peak value comply with QP limit Below 1GHz.The EUT deemed to comply with QP limit. But the Peak value and average value both need to comply with applicable limit above 1GHz.

For the actual test configuration, please see the test setup photo.

3.3. Test Setup

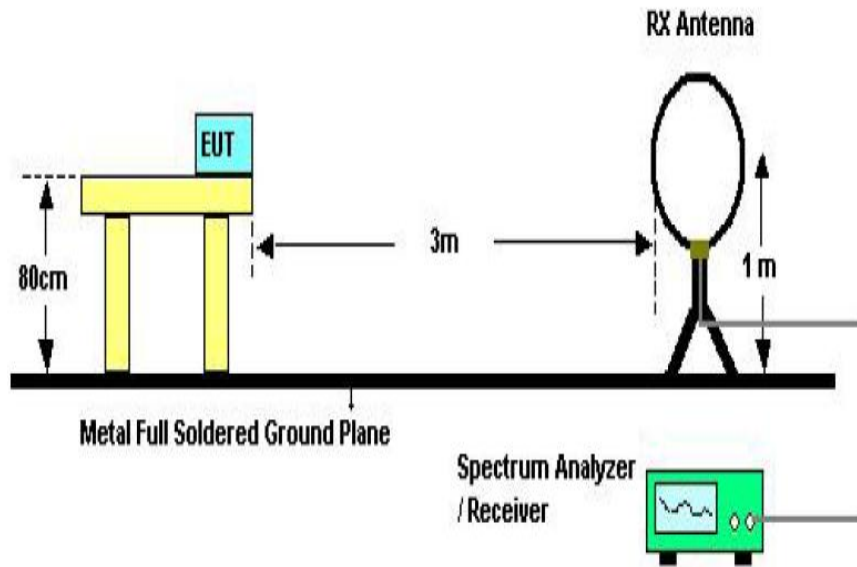

Below 30MHz Test Setup

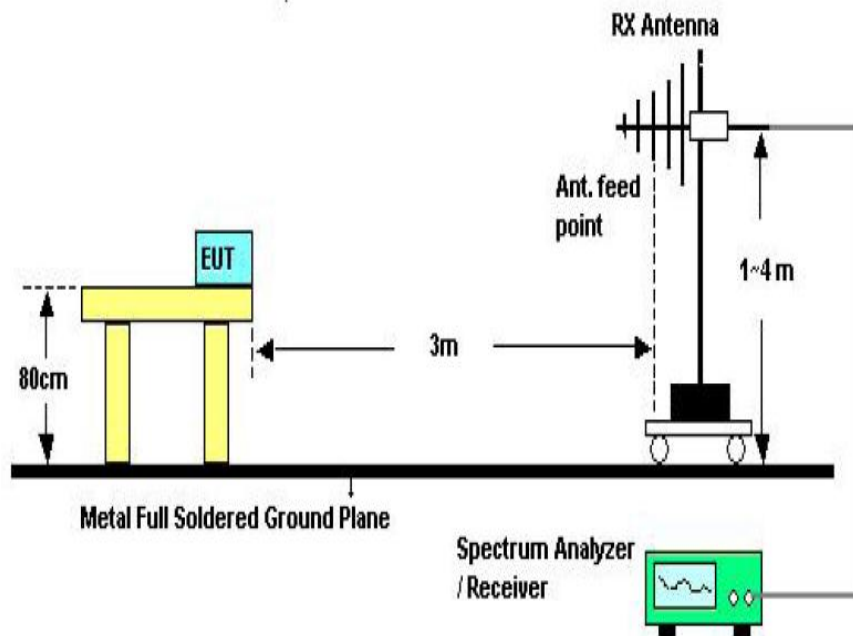

Above 30MHz Test Setup

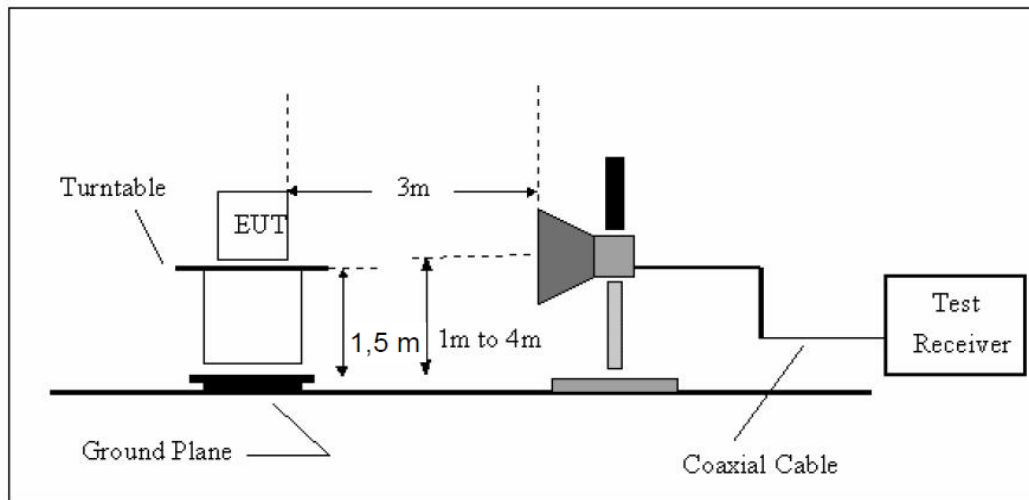

Above 1GHz Test Setup

3.4. Test Results

Test Condition

Continual Transmitting in maximum power.

9KHz~150KHz	RBW200Hz	VBW1KHz
150KHz~30MHz	RBW9KHz	VBW 30KHz
30MHz~1GHz	RBW120KHz	VBW 300KHz
Above1GHz	RBW1MHz	VBW 3MHz

We have scanned the 10th harmonic from 9 kHz to the EUT.

Detailed information please see the following page.

From 9KHz to 30MHz: Conclusion: PASS

Note: 1. The amplitude of spurious emissions which are attenuated by more than 20dB below the permissible value has no need to be reported.

2. Only show the test data of the worst Channel in this report.

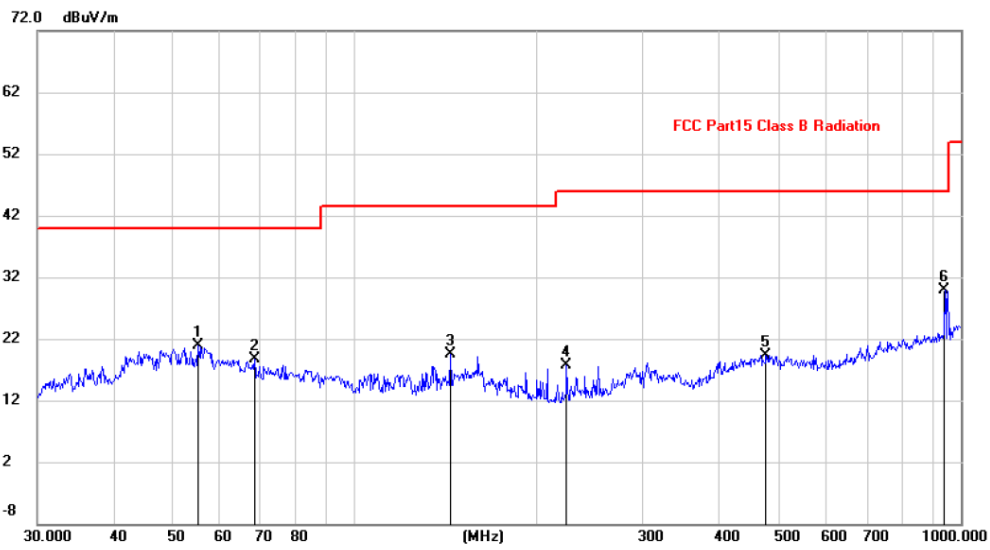

No. Mk.	Freq.	Reading Level	Correct Factor	Measurement	Limit	Margin	Antenna Height	Table Degree
	MHz	dBuV	dB	dBuV/m	dBuV/m	dB	cm	degree
1	55.2207	7.64	13.25	20.89	40.00	-19.11	peak	
2	68.3906	7.29	11.35	18.64	40.00	-21.36	peak	
3	143.8291	5.47	14.11	19.58	43.50	-23.92	peak	
4	224.5192	6.08	11.53	17.61	46.00	-28.39	peak	
5	478.8455	2.31	17.06	19.37	46.00	-26.63	peak	
6 *	942.1304	6.71	23.18	29.89	46.00	-16.11	peak	

Note:1. *:Maximum data; x:Over limit; !:over margin.

2.Measurement=Reading Level+Correct Factor; Correct Factor=Antenna Factor+Cable Loss.

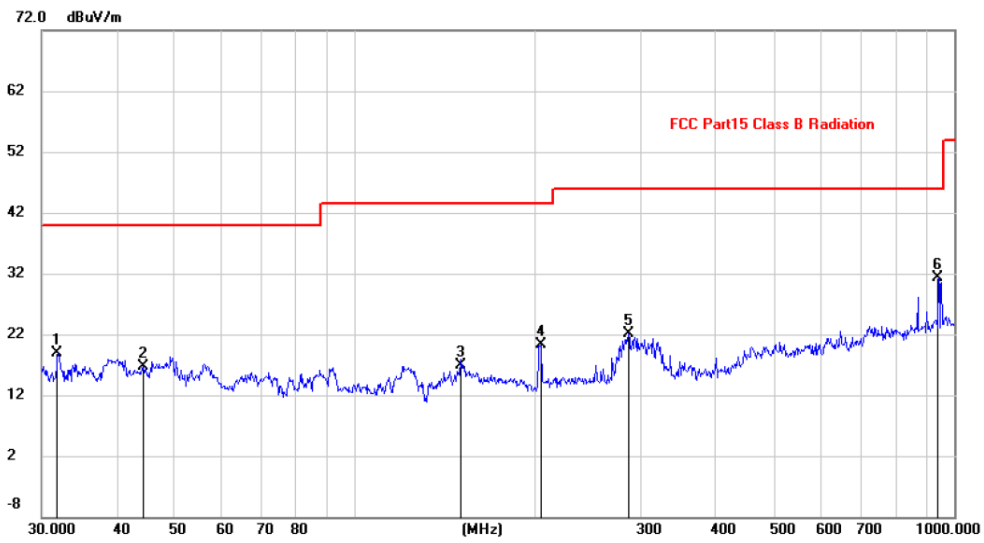

No.	Mk.	Freq.	Reading Level	Correct Factor	Measurement	Limit	Margin	Antenna Height	Table Degree
		MHz	dBuV	dB	dBuV/m	dBuV/m	dB	cm	degree
1		31.9542	5.55	13.39	18.94	40.00	-21.06	peak	
2		44.2751	2.79	13.82	16.61	40.00	-23.39	peak	
3		150.5377	2.30	14.55	16.85	43.50	-26.65	peak	
4		204.2375	9.78	10.48	20.26	43.50	-23.24	peak	
5		285.9778	9.06	13.06	22.12	46.00	-23.88	peak	
6	*	942.1304	8.13	23.18	31.31	46.00	-14.69	peak	

Note: 1. *:Maximum data; x:Over limit; !:over margin.

2.Measurement=Reading Level+Correct Factor; Correct Factor=Antenna Factor+Cable Loss.

Notes: Above is below 1GHz test data. This report only shall the worst case mode for TX 2402MHz.

From 1G-25GHz

Test Mode: TX Low									
Freq (MHz)	Read Level (dBuV/m)	Polar (H/V)	Antenna Factor (dB/m)	Cable loss(dB)	Amp Factor (dB)	Result (dBuV/m)	Limit (dBuV/m)	Margin (dB)	Remark
4804	43.20	V	33.95	10.18	34.26	53.07	74	20.93	PK
4804	32.14	V	33.95	10.18	34.26	42.01	54	11.99	AV
7206	/		/						
9608	/		/						
4804	42.89	H	33.95	10.18	34.26	53.69	74	20.31	PK
4804	31.67	H	33.95	10.18	34.26	41.72	54	12.28	AV
7206									
9608									
Test Mode: TX Mid									
4880	41.03	V	33.93	10.2	34.29	50.87	74	23.13	PK
4880	32.14	V	33.93	10.2	34.29	41.98	54	12.02	AV
7320	/								
9760	/								
4880	41.90	H	33.93	10.2	34.29	51.74	74	22.26	PK
4880	32.52	H	33.93	10.2	34.29	42.36	54	11.64	AV
7320									
9760									
Test Mode: TX High									
4960	42.15	V	33.98	10.22	34.25	52.10	74	21.90	PK
4960	32.95	V	33.98	10.22	34.25	42.90	54	11.10	AV
7440	/								
9920	/								
4960	42.69	H	33.98	10.22	34.25	52.64	74	21.36	PK
4960	31.41	H	33.98	10.22	34.25	41.36	54	12.64	AV
7440	/								
9920	/								
Note:									
1, Result = Read level + Antenna factor + cable loss-Amp factor									
2, All the other emissions not reported were too low to read and deemed to comply with FCC limit.									

4. Power Line Conducted Emission

4.1. Test Limits

Frequency MHz	Limits dB(μ V)	
	Quasi-peak Level	Average Level
0.15 -0.50	66 -56*	56 - 46*
0.50 -5.00	56	46
5.00 -30.00	60	50

- Notes: 1. *Decreasing linearly with logarithm of frequency.
 2. The lower limit shall apply at the transition frequencies.
 3. The limit decreases in line with the logarithm of the frequency in rang of 0.15 to 0.50 MHz.

4.2. Test Procedure

The EUT is put on the plane 0.8m high above the ground by insulating support and is connected to the power mains through a line impedance stabilization network (L.I.S.N.). This provides a 50ohm coupling impedance for the EUT system. Please refer the block diagram of the test setup and photographs. Both sides of AC lines are checked to find out the maximum conducted emission. In order to find the maximum emission levels, the relative positions of equipment and all of the interface cables shall be changed according to ANSI C63.4:2014 on Conducted Emission Measurement.

The bandwidth of test receiver is set at 9 kHz.

4.3. Test Setup

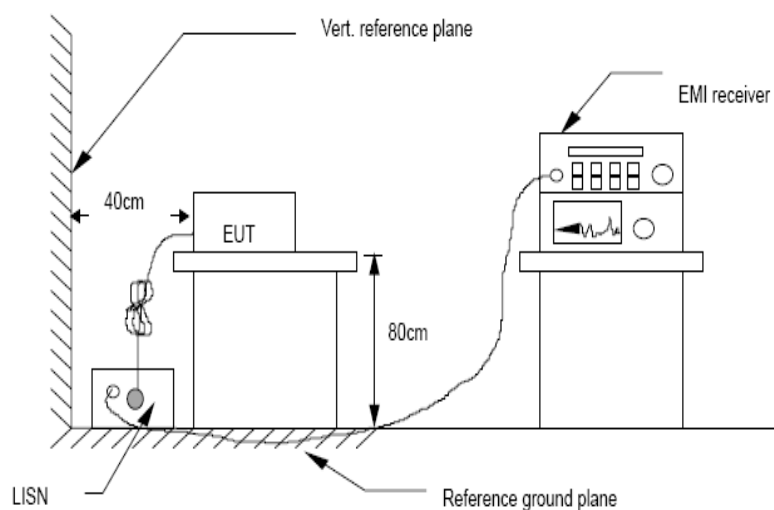

4.4. Test Results

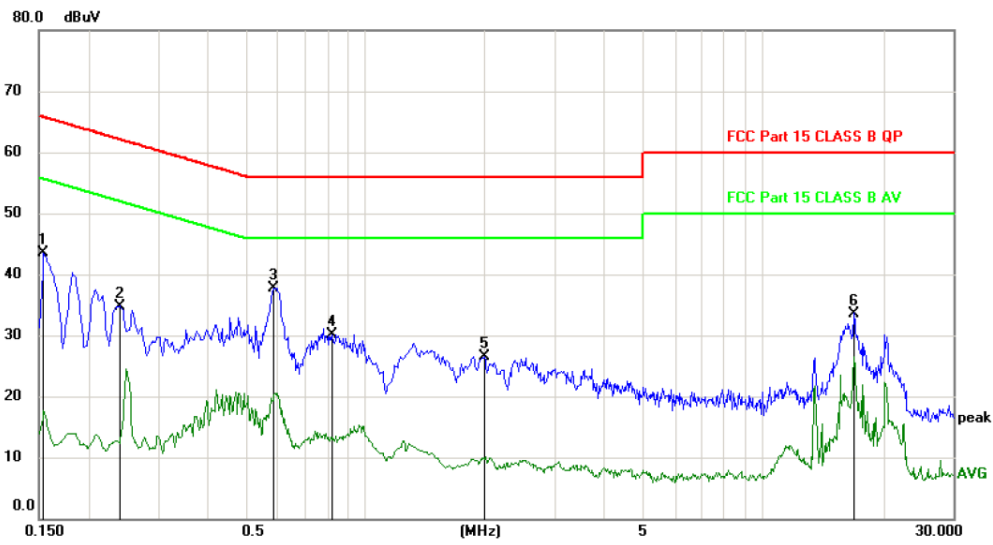

No. Mk.	Freq. MHz	Reading Level dBuV	Correct Factor dB	Measure- ment dBuV	Limit dBuV	Margin dB	Detector	Comment
1	0.1545	33.85	9.73	43.58	65.75	-22.17	peak	
2	0.2404	24.88	9.75	34.63	62.08	-27.45	peak	
3 *	0.5865	27.96	9.79	37.75	56.00	-18.25	peak	
4	0.8205	20.38	9.81	30.19	56.00	-25.81	peak	
5	1.9805	16.58	9.92	26.50	56.00	-29.50	peak	
6	16.9005	23.14	10.46	33.60	60.00	-26.40	peak	

*:Maximum data x:Over limit !:over margin (Reference Only)

Note: Measurement=Reading Level+Correc Factor. Factor=(LISN or ISN or PLC or Current Probe)Factor+Cable

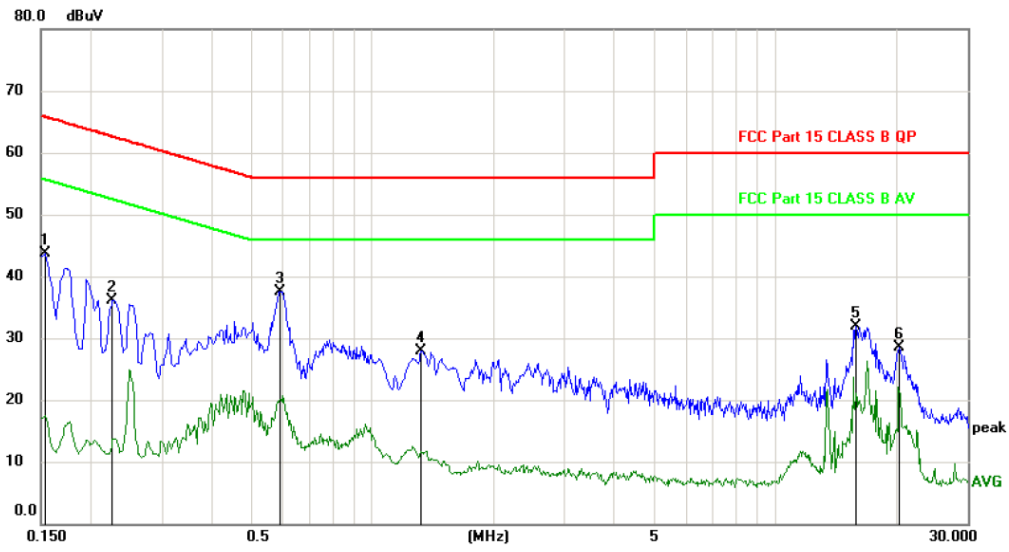

No. Mk.	Freq. MHz	Reading Level dBuV	Correct Factor dB	Measurement dBuV	Limit dBuV	Margin dB	Detector	Comment
1	0.1545	33.92	9.73	43.65	65.75	-22.10	peak	
2	0.2265	26.37	9.75	36.12	62.58	-26.46	peak	
3 *	0.5910	27.72	9.79	37.51	56.00	-18.49	peak	
4	1.3204	18.07	9.85	27.92	56.00	-28.08	peak	
5	15.8605	21.47	10.47	31.94	60.00	-28.06	peak	
6	20.3205	17.95	10.52	28.47	60.00	-31.53	peak	

*:Maximum data x:Over limit !:over margin (Reference Only)

Note: Measurement=Reading Level+Correc Factor. Factor=(LISN or ISN or PLC or Current Probe)Factor+Cable

Remark: All modes and channels have been tested and only listed BT link mode that is worst data

5 Conducted Maximum Output Power

5.1 Test limits

Please refer section RSS-247 & 15.247.

5.2 Test Procedure

Details see the KDB558074 D01 Meas Guidance V04

5.2.1 Place the EUT on the table and set it in transmitting mode.

5.2.2 Measure out each mode and each bands peak output power of EUT.

Note: The cable loss and attenuator loss were offset into measure device as amplitude offset.

5.3 Test Setup

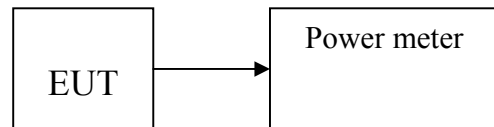

5.4 Test Results

Channel	Frequency (MHz)	PK Output Power (dBm)	PK Output Power (mW)	Limit (dBm)
CH1	2402	2.714	1.868	30
CH20	2440	2.646	1.839	30
CH40	2480	3.863	2.434	30
Conclusion: PASS				

6 Peak Power Spectral Density

6.1 Test limits

- 6.1.1 Please refer section RSS-247 & 15.247.
- 6.1.2 For direct sequence systems, the peak power spectral density conducted from the intentional radiator to the antenna shall not be greater than 8dBm in any 3kHz band during any time interval of continuous transmission.
- 6.1.3 The direct sequence operating of the hybrid system, with the frequency hopping operation turned off, shall comply with the power density requirements of paragraph (d) of this section.

6.2 Test Procedure

Details see the KDB558074 D01 Meas Guidance V04

- 6.2.1 Place the EUT on the table and set it in transmitting mode.
- 6.2.2 Remove the antenna from the EUT and then connect a low loss RF cable from the antenna port to the spectrum analyzer.
- 6.2.3 Set the spectrum analyzer as RBW = 10kHz, VBW = 30kHz, span=5-30%EBW, detail see the test plot.
- 6.2.4 Record the max reading.
- 6.2.5 Repeat the above procedure until the measurements for all frequencies are completed.

6.3 Test Setup

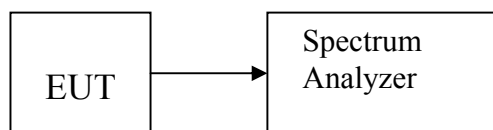

6.4 Test Results

Channel	Frequency (MHz)	Power Spectral Density (dBm)	Limit (dBm)	Result
CH1	2402	-11.144	8	PASS
CH20	2440	-10.207	8	PASS
CH40	2480	-10.288	8	PASS

Conclusion: PASS

CH Low :

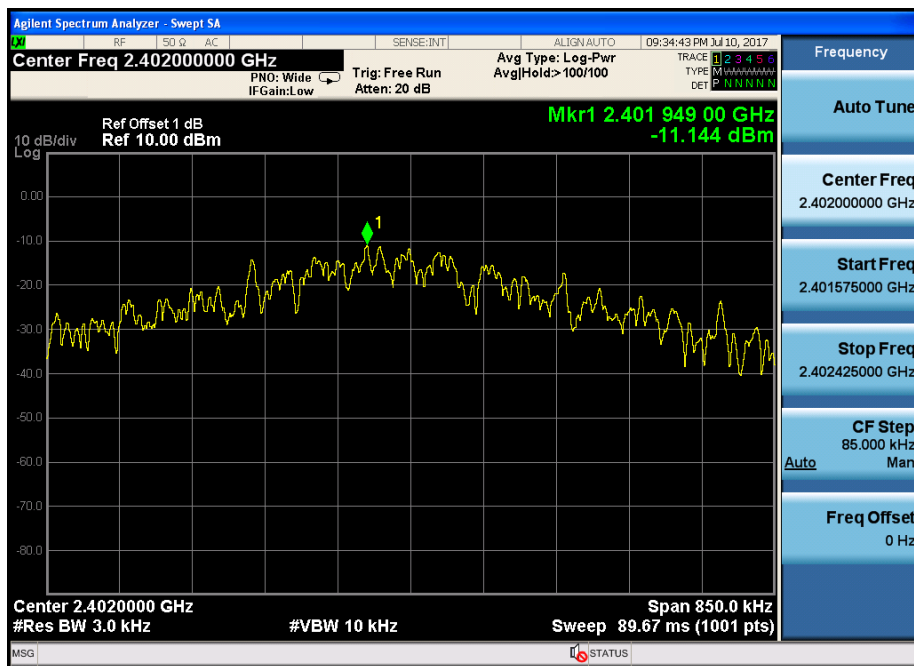

CH Mid:

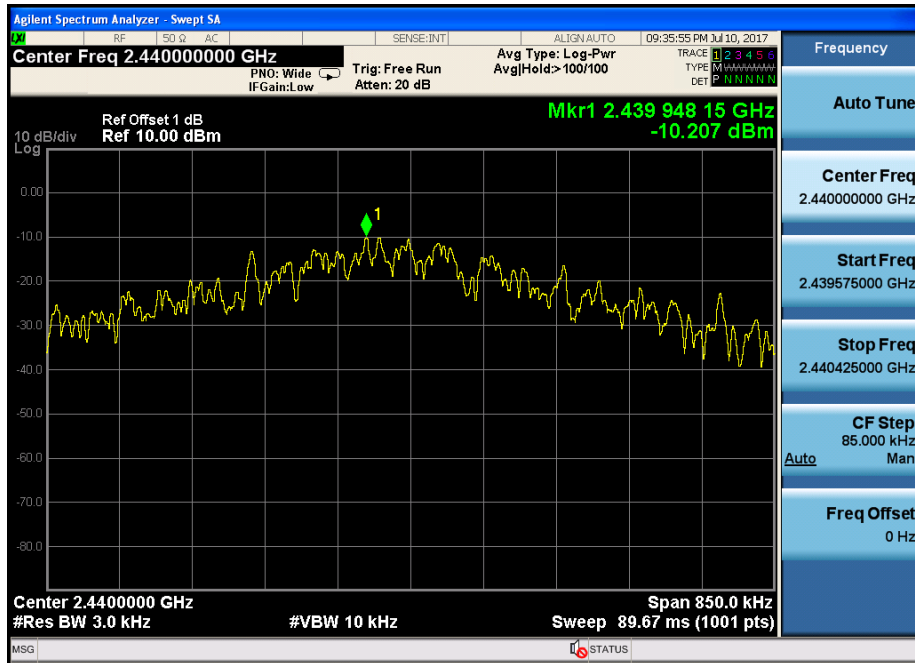

CH High:

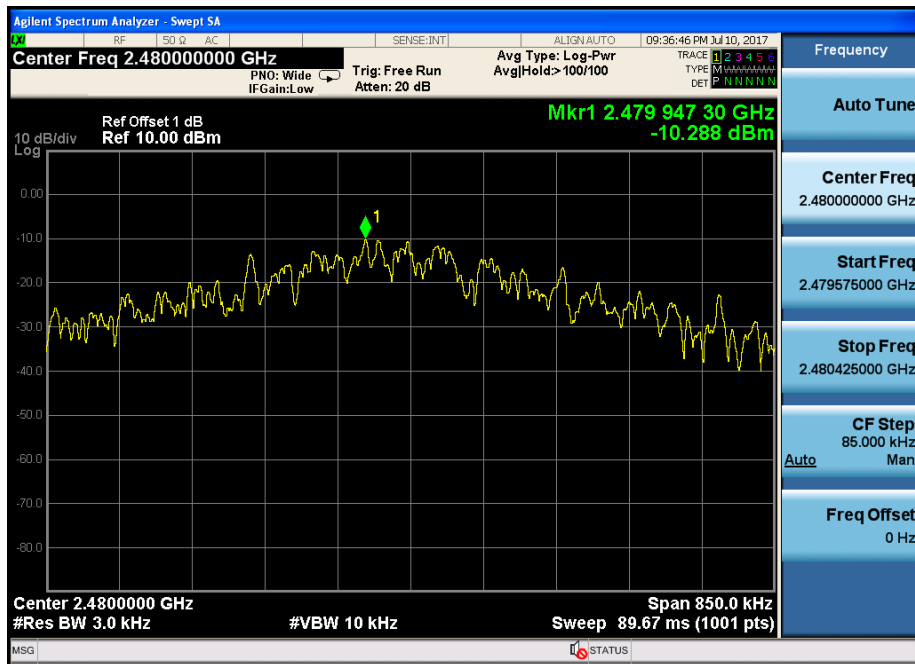

7 Bandwidth

7.1 Test limits

Please refer section RSS-247 & 15.247

For direct sequence systems, the minimum 6dB bandwidth shall be at least 500 kHz.

7.2 Test Procedure

Details see the KDB558074 D01 Meas Guidance V04

a) The bandwidth is measured at an amplitude level reduced 20dB from the reference level. The reference level is the level of the highest amplitude signal observed from the transmitter at the fundamental frequency. Once the reference level is established, the equipment is conditioned with typical modulating signal to produce the worst-case (i.e. the widest) bandwidth.

b) The test receiver set RBW = 1-5 % EBW, VBW \geq 3RBW, Sweep time set auto, detail see the test plot.

7.3 Test Setup

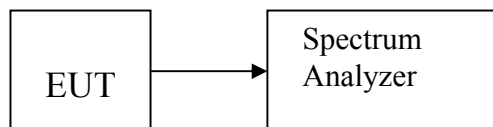

7.4 Test Results

Channel	Frequency (MHz)	6dB Bandwidth (MHz)	Limit (MHz)	Result
CH1	2402	0.511	0.5	PASS
CH20	2440	0.513	0.5	PASS
CH40	2480	0.510	0.5	PASS

:
CH Low :



CH Mid :

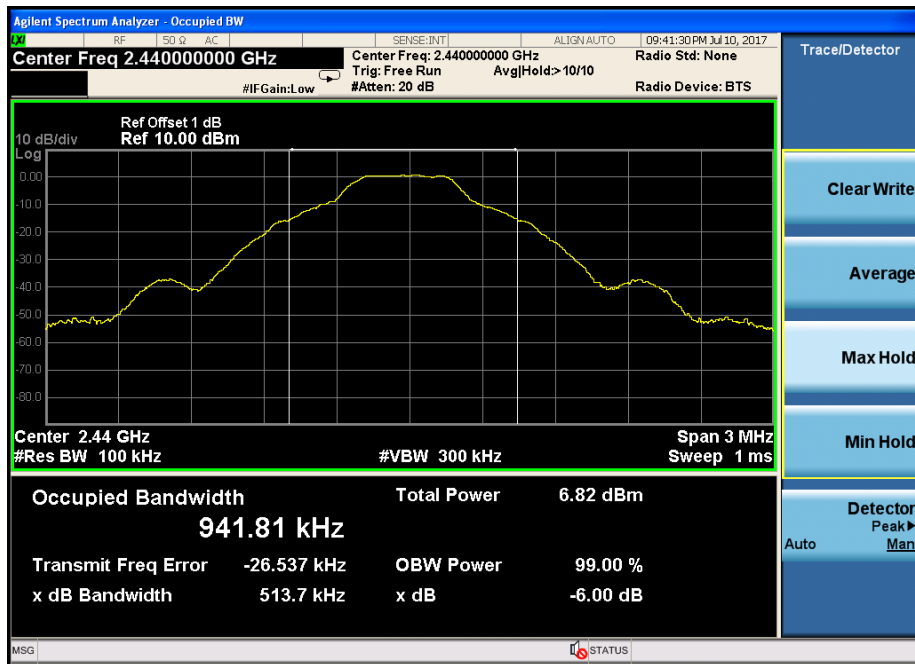

CH High :

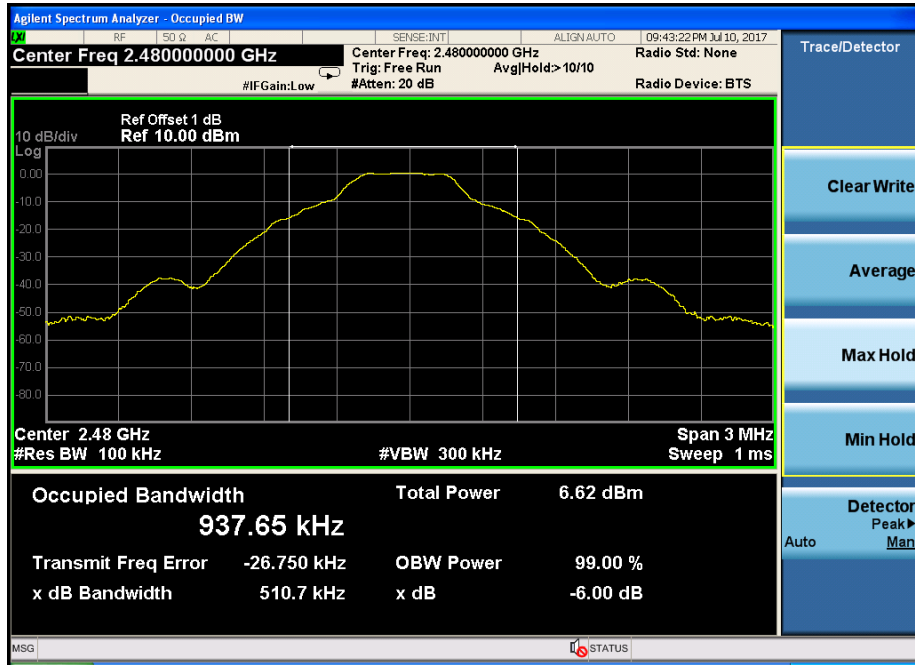

8 Band Edge Check

8.1 Test limits

Please refer section RSS-GEN&15.247.

8.2 Test Procedure

Details see the KDB558074 D01 Meas Guidance V04

8.2.1 Put the EUT on a 0.8m high table, power on the EUT. Emissions were scanned and measured rotating the EUT to 360 degrees, Find the maximum Emission

8.2.2 Check the spurious emissions out of band.

8.2.3 RBW 1MHz ,VBW 3MHz ,peak detector for peak value , RBW 1MHz ,VBW 3MHz ,RMS detector for AV value.

8.3 Test Setup

Same as 5.2.2.

8.4 Test Results

Radiated Method:

Test mode: GFSK Tx Low									
Freq (MHz)	Read Level (dBuV/m)	Polar (H/V)	Antenna Factor (dB/m)	Cable loss (dB)	Amp Factor (dB)	Result (dBuV/m)	Limit (dBuV/m)	Margin (dB)	Remark
2390	53.88	V	27.62	3.92	34.97	50.45	74	23.55	PK
2390	42.46	V	27.62	3.92	34.97	39.03	54	14.97	AV
2390	53.90	H	27.62	3.92	34.97	50.47	74	23.53	PK
2390	--	H	--	--	--	--	54	--	AV
Test mode: GFSK Tx High									
2483.5	54.30	V	27.89	4	34.97	51.22	74	22.78	PK
2483.5	--	V	--	--	--	--	54	--	AV
2483.5	53.92	H	27.89	4	34.97	50.84	74	23.16	PK
2483.5	--	H	--	--	--	--	54	--	AV

Note:

1, Result = Read level + Antenna factor + cable loss-Amp factor

2, All the other emissions not reported were too low to read and deemed to comply with FCC limit.

Conducted Method:
GFSK

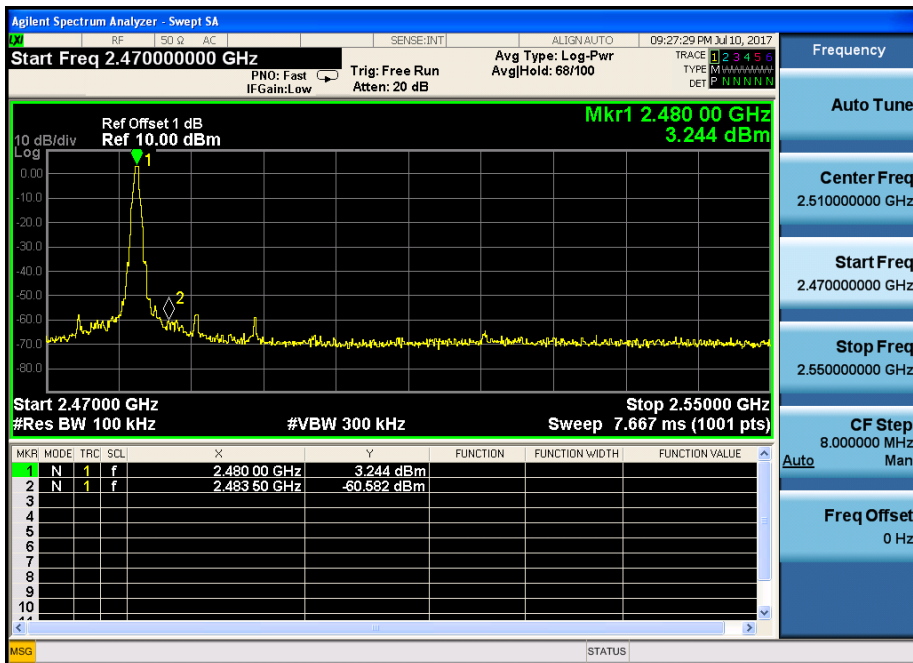
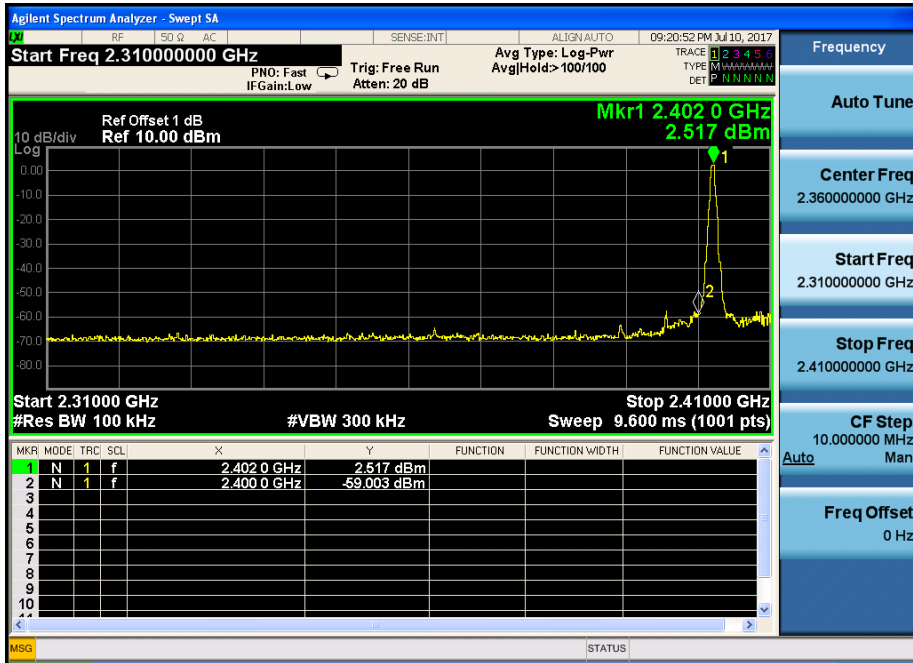

9 Antenna Requirement

9.1 Standard Requirement

An intentional radiator shall be designed to ensure that no antenna other than that furnished by the responsible party shall be used with the device. The use of a permanently attached antenna or of an antenna that uses a unique coupling to the intentional radiator shall be considered sufficient to comply with the provisions of this Section. The manufacturer may design the unit so that a broken antenna can be replaced by the user, but the use of a standard antenna jack or electrical connector is prohibited.

9.2 Antenna Connected Construction

The antenna is PCB antenna and no consideration of replacement. Please see EUT photo for details.

9.3 Results

The EUT antenna is PCB Antenna. It comply with the standard requirement.

-----THE END OF REPORT-----